







Metal Train Rack

This product is shipped as two pieces and must be assembled. Assembly is straight-forward following the below instructions. Once assembled, the item is meant to be mounted to a wall.

Note: This item is meant for drywall/wood stud mounting only. If your walls are made from concrete, brick or plaster, please consult your local hardware store for assistance. We recommend that two people work together to install this item.

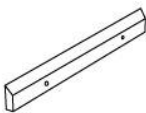
PARTS INCLUDED:

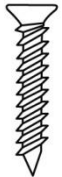
A 	B 	C 	D 	E 
7PCS	1PC	1PC	2PCS	2PCS

• ASSEMBLY INSTRUCTIONS:

1. Attach the rack to the wood board by aligning the rack holes with seven threaded holes.
2. Spin nut (A) (clockwise) onto each exposed threaded portion of each threaded stud by using the wrench (B) to tighten each nut.

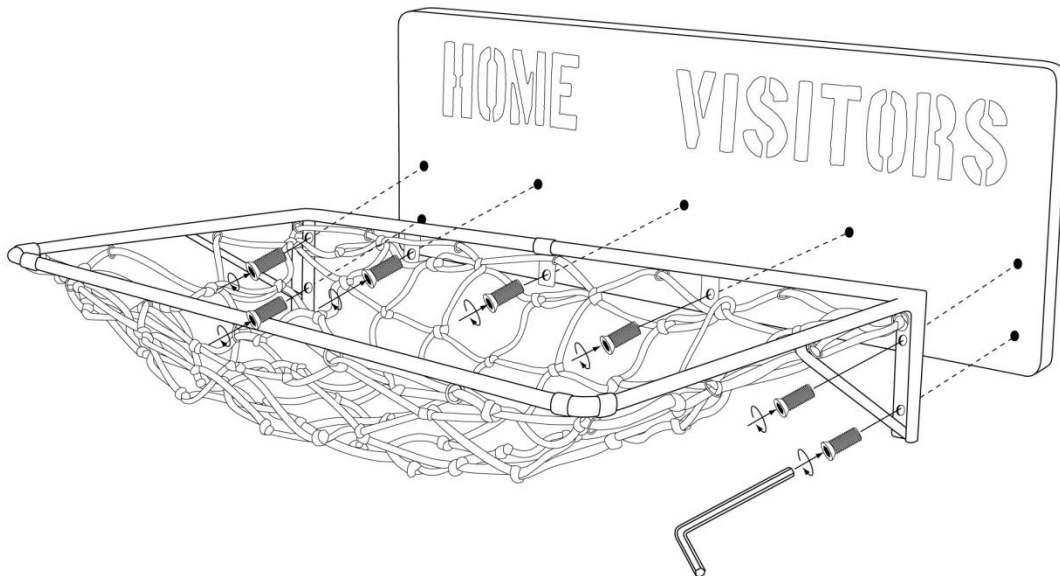

MOUNTING INSTRUCTIONS:

Tools required (not included): Screwdriver, Level, Tape measure, Pencil, Stud-Finder

This item is meant to be mounted to a wall using a French cleat mounting system which includes a wall-mounted cleat and a product-mounted cleat. The wall-mounted cleat is mounted to the wall using the provided fasteners and is thereafter used to engage with and support the product-mounted cleat to safely hold the item against the wall. The wall-mounted cleat includes a sharp edge that must be facing up and away from the wall for this French cleat mounting system to work properly.

1. With the help of a friend, hold the product against the wall at a desired hanging location. Use a level to make sure the product is level and lightly mark the wall along the entire top edge of the product with a pencil. Set the product aside with access to the rear surface.
2. You will notice that a removable wooden wall cleat is taped in place on the rear of the product. Keeping the cleat in place, use a tape measure to measure a "cleat distance" between the top edge of the product and the lower edge of the removable wall cleat. Record this measurement and remove the cleat.
3. Use the pencil and the tape measure to draw a second line located below the line you made in Step (1). The second lower line is spaced the distance you measured in Step (2).
4. Now hold the cleat against the wall so that its bottom edge aligns with the second lower line. Orient the cleat so that the sharp edge of the cleat is positioned up and away from the wall, as shown in the illustration. While holding the cleat level, use the pencil (or a sharp implement, such as one of the provided long screws) to mark the wall through the two holes of the cleat. Set the cleat aside.
5. Use a screwdriver to install an anchor (D) into the wall at each of the two marks made in Step (4). Rotate the anchor clockwise while pushing it gently into the wall until the wide head of the anchor becomes even with the wall surface. Do not over-tighten. Repeat this step with the other mark and anchor. Note that if either mark aligns with a wall-stud, just use a provided screw at that mark during step (6).
6. Place the cleat so that the holes align with the installed anchors and use the screwdriver to secure a screw (E) through the cleat and into the installed anchor. Rotate the screws clockwise until tight. **MAKE SURE THAT THE SHARP EDGE OF THE CLEAT IS POSITIONED AWAY FROM THE WALL AND FACES UP!**
7. With help of another person, lift the product over the cleat. Gently lower the product until the cleat on product firmly engages the wall-mounted cleat. Before releasing your grip on the product, gently pull the top part of the product to confirm that the cleats are engaged.

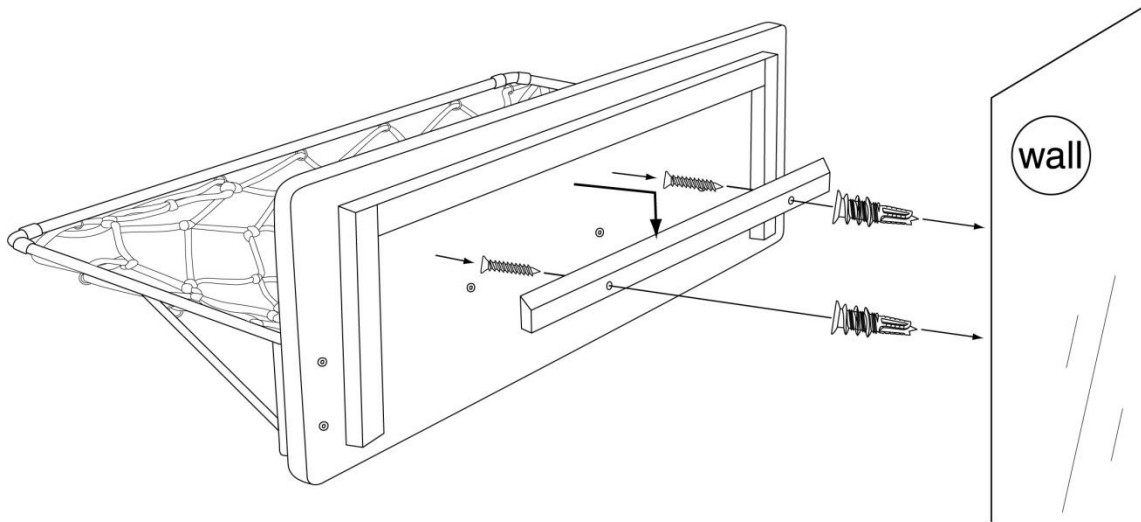

CARE INSTRUCTIONS:

- *Dust often with a soft, dry cloth
- *Avoid using strong chemicals or abrasive cleaners.

Thank you for your purchase
www.pbteen.com