

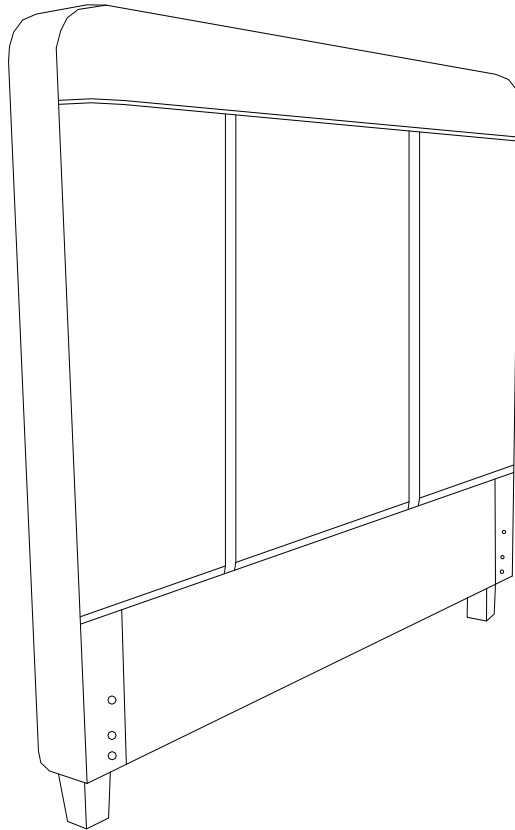

## LEATHER HEADBOARD

### ASSEMBLY INSTRUCTIONS



**Important Safety Instructions:**

- Please read all instructions carefully before assembling.
- For your safety, assembly by two or more adults is strongly recommended.
- Keep instructions for future use.
- Use only vendor supplied hardware to assemble. Using unauthorized hardware could jeopardize the structural integrity of the item.

**Pre-assembly:**

- Remove all parts and hardware from the box and lay out on a clear carpeted or scratch-free work surface, as this will avoid damaging parts during assembly. The shipping box provides an ideal work surface.
- Do not dispose of any packaging or contents of the shipping carton until assembly is completed to avoid accidentally discarding small parts or hardware.
- Use the parts and hardware lists below to identify and separate each of the pieces included.
- The illustrations provided allow for easier assembly when used in conjunction with the assembly instructions.
- The use of power tools to aid in assembly is not recommended. Power tools can damage hardware and split wood.

**Parts Included:**

(A) Leather Headboard 1x

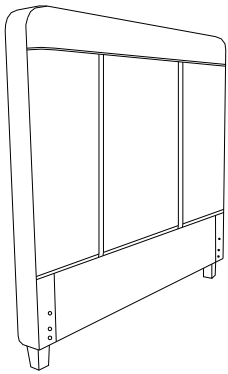

**Hardware Included:**

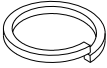
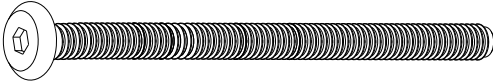
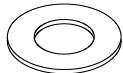
<p>(B) Spring Washer  M6mm 6x</p>	<p>(C) Bolt  M6 x 60 mm 6x</p>	<p>(D) Flat Washer  M6mm 6x</p>
--	--	--

**Tools Required:**

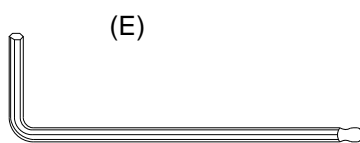

Allen Key

### Assembly Instruction Steps:

1. When used with Metal Bed Frame (sold separately), hold the Headboard (A) upright near the desired location. Slide a Flat washer (D), Spring Washer (B) onto each Bolt (C), then insert 3 Bolts (C) through the holes of conjunction of Metal Bed Frame, into pre-drilled holes in the bottom front side of Headboard (A). Use the Allen Key (E) to tighten Bolts (C).

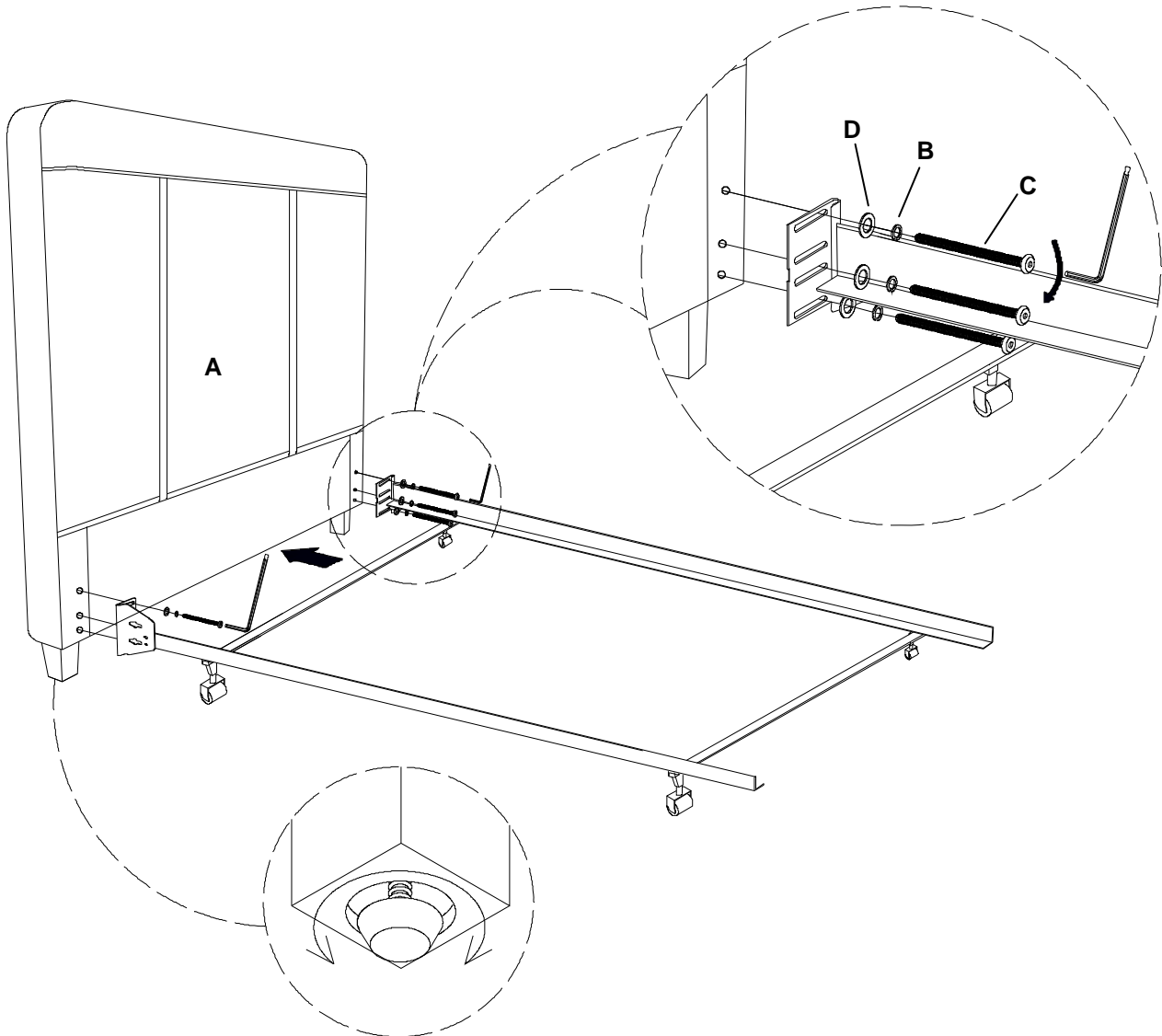

### 2. Adjusting the levelers:

Due to an uneven floor, the furniture may not sit level due causing it to wobble. If the furniture wobbles, determine which corner does not touch the ground correctly. With two people follow these steps:

- 1) Carefully elevate the item slightly to provide access to the levelers attached to the bottom.
- 2) Turn the levelers until adequate contact will be made with the floor. Gently set down the piece and check stability.
- 3) Repeat steps until furniture sits firmly on the ground.

### Care Instructions:

- Cares must be taken to protect the leather surface to prevent it from being cut by hard or sharp objects, or to be stained with oil.
- Dusts or dirt must be removed immediately with a clean, soft, slightly moist and lint-free cloth.
- If the leather gets wet with water, please soak up moisture immediately with a clean, soft, dry cloth. Leather should be air dried in a cool and ventilated place and should not be exposed under the direct sunshine or air dried under the high temperature.
- We do not recommend the use of chemical cleansers, abrasives or furniture polish on our lacquered finish.
- Hardware may loosen over time. Periodically check to make sure all connections are tight. Re-tighten if necessary.