

LOCKER WALL SYSTEM

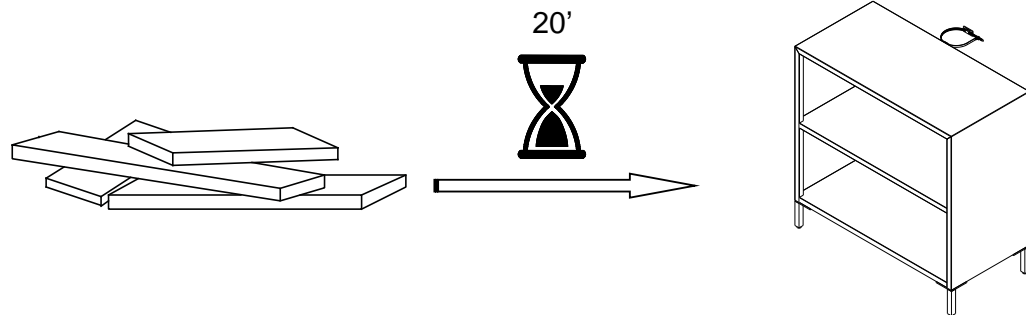

⚠ ENGLISH

- Do not dispose of any packaging or contents of the shipping carton until assembly is completed to avoid accidentally discarding small parts or hardware.

⚠ FRANÇAIS

- Ne jetez rien des produits d'emballage et du contenu de la boîte jusqu'à ce que l'assemblage soit terminé, afin d'éviter de jeter par mégarde de petites pièces ou des morceaux.

⚠ ESPAÑOL

- Para evitar desechar accidentalmente las partes pequeñas o las piezas de ferretería, no tirar el embalaje o contenido de la caja hasta que el ensamblaje esté completo.

Care Instructions:

- Dust often using a clean, soft, dry and lint-free cloth.
- Blot spills and wipe with a clean, damp cloth immediately.
- We do not recommend the use of chemical cleansers, abrasives or furniture polish on our lacquered finish.
- Hardware may loosen over time. Periodically check to make sure all connections are tight. Re-tighten if necessary.

Instructions d'entretien :

- Éponser régulièrement avec un chiffon propre, doux et non pelucheux.
- Éponger immédiatement les liquides renversés et essuyer à l'aide d'un chiffon propre et humide.
- L'utilisation de produits nettoyants chimiques, d'abrasifs ou d'encaustiques sur nos finitions laquées n'est pas recommandée.
- Le matériel de fixation peut se desserrer avec le temps. Vérifiez régulièrement afin de vous assurer que tous les raccords sont bien serrés. Resserrez-les au besoin.

Instrucciones de cuidado:

- Limpiar el polvo con un trapo limpio, suave, seco y libre de pelusas.
- Secar los derrames de inmediato y limpiar con un trapo limpio y húmedo.
- Recomendamos no usar limpiadores químicos, abrasivos o lustramuebles sobre el acabado barnizado.
- Las piezas de ferretería pueden aflojarse con el tiempo. Controlar periódicamente que estén bien ajustadas. Si es necesario, volver a ajustarlas.

Williams-Sonoma Inc.

Assembly Instructions
Instructions d'assemblage
Instrucciones de Ensamblaje

Pottery Barn – Pottery Barn Teen – Pottery Barn Kids – Williams Sonoma Home – West Elm – Rejuvenation – Mark and Graham – GreenRow

23-December-2023

3/10

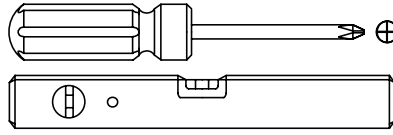
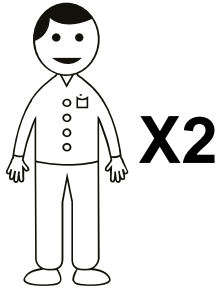

NOT INCLUDED / NON INCLUS / NO INCLUIDAS

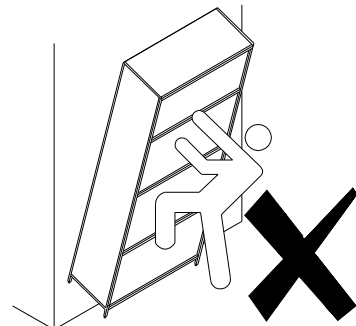
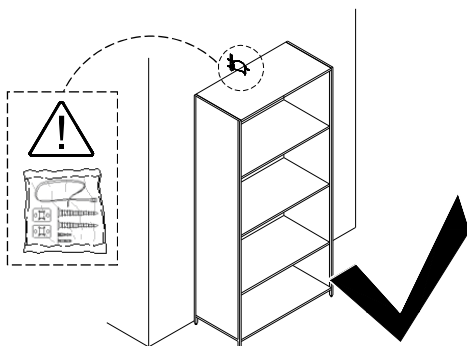
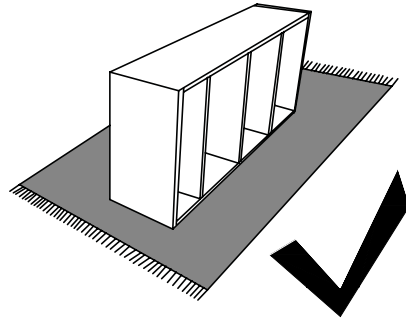
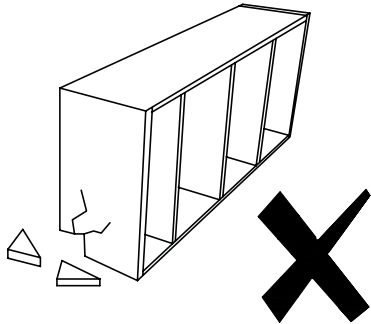
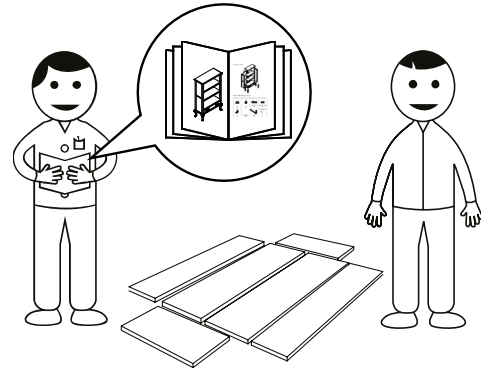
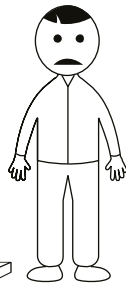
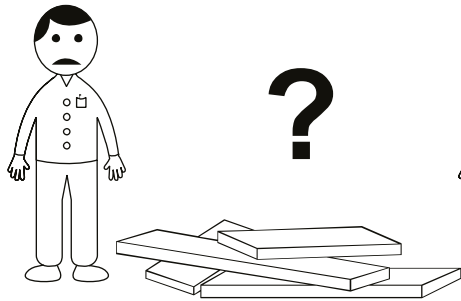
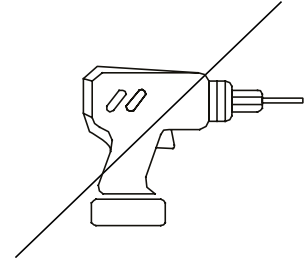

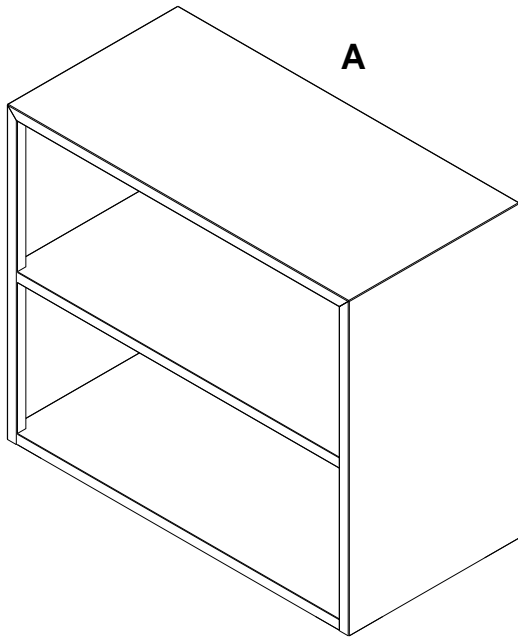

Locker Wall System Base
Base du système mural de casier
Base del sistema de pared con armario

(Sold separately)
(Vendu séparément)
(Se vende por separado)

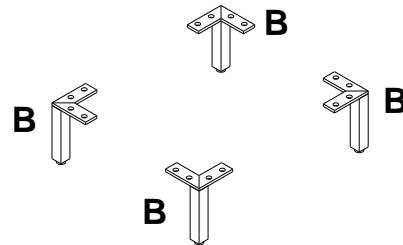

HARDWARE INCLUDED / (MATÉRIEL INCLUS) / (PIEZAS DE FERRETERÍA INCLUIDAS)

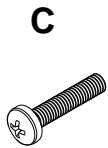

C
JP M4x10mm
4x



D
4x

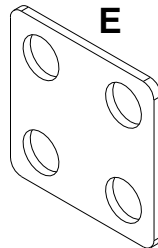

E
1x

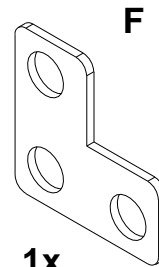

F
1x



G
Anti-tip kit
Dispositif anti-basculement
Kit anti-volcada

1x

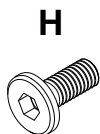

H
M6x20
16x

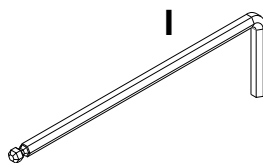

I
#4
1x

HARDWARE INCLUDED from Locker Wall System Base
MATÉRIEL INCLUS à partir de la base du système mural de casier
PIEZAS DE FERRETERÍA INCLUIDAS de la base del sistema de pared con armario

1

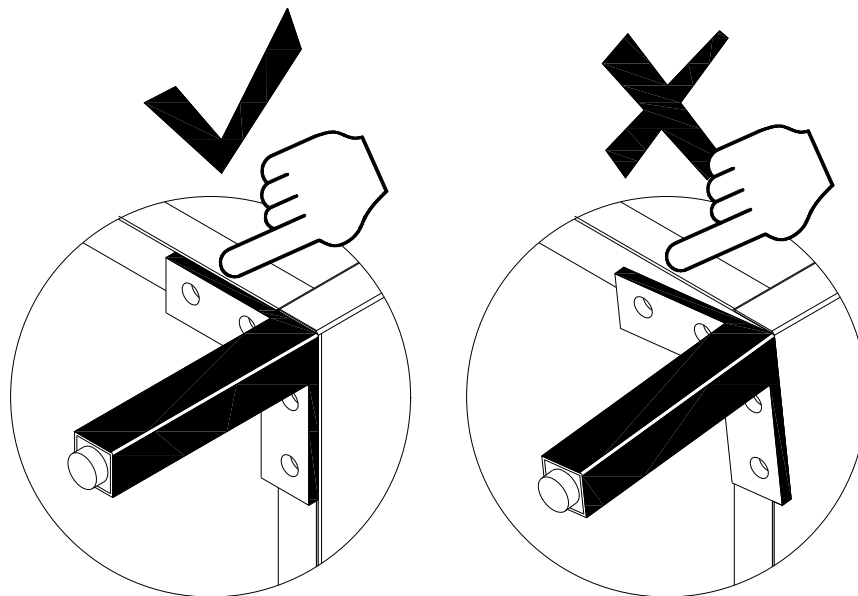
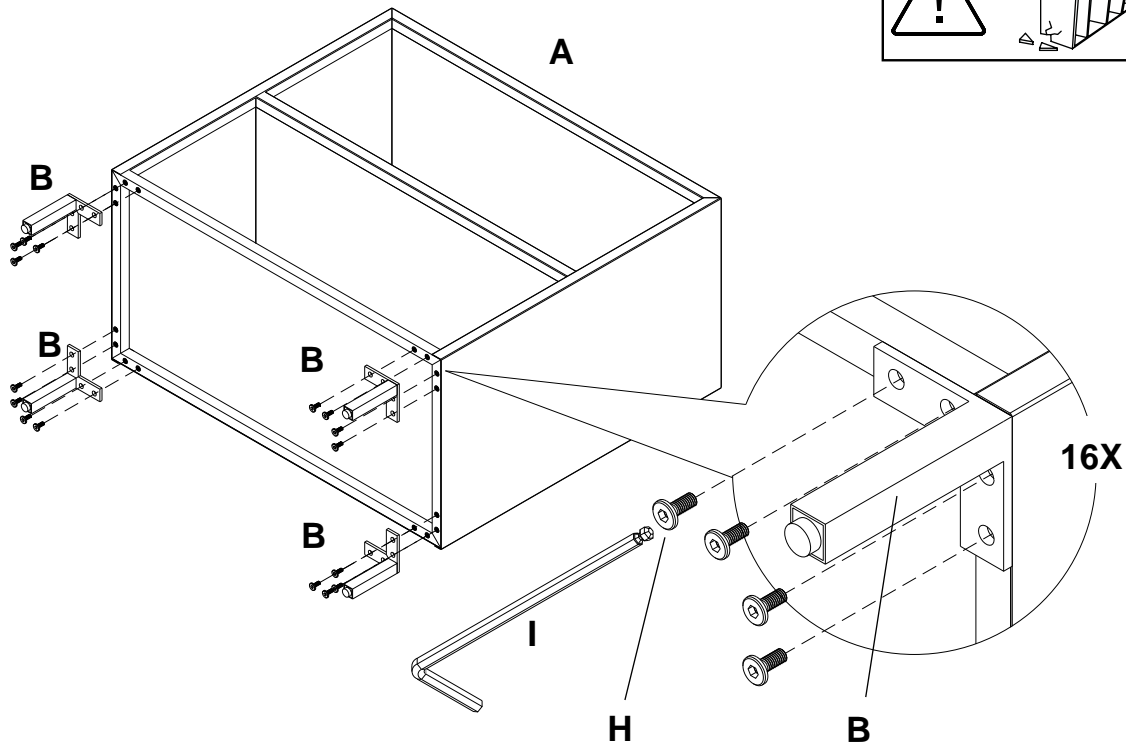
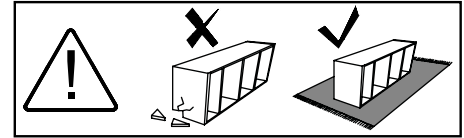

2

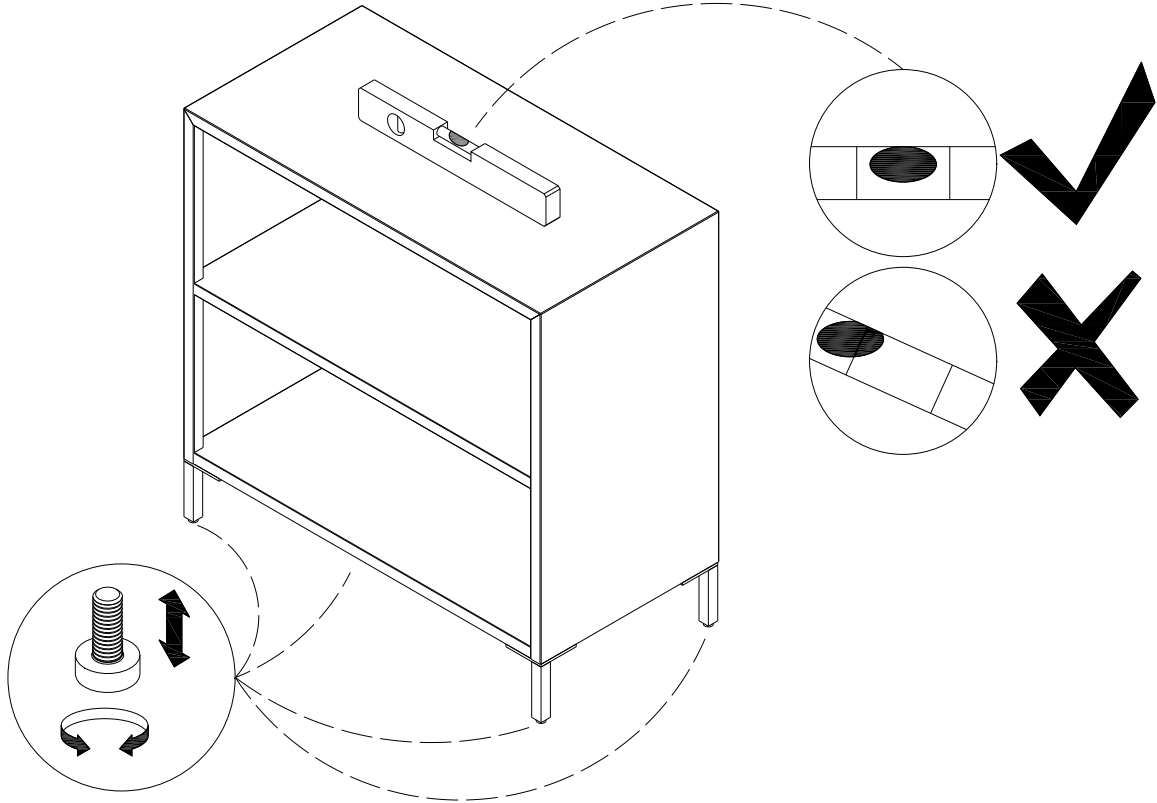

3

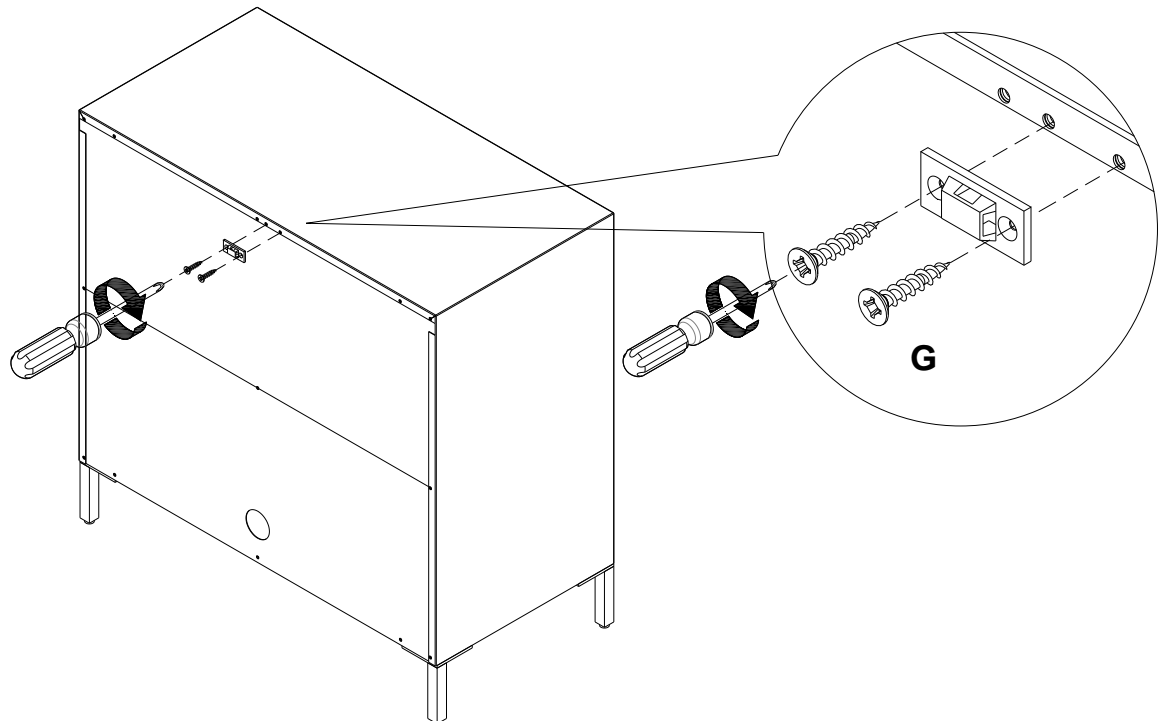

4

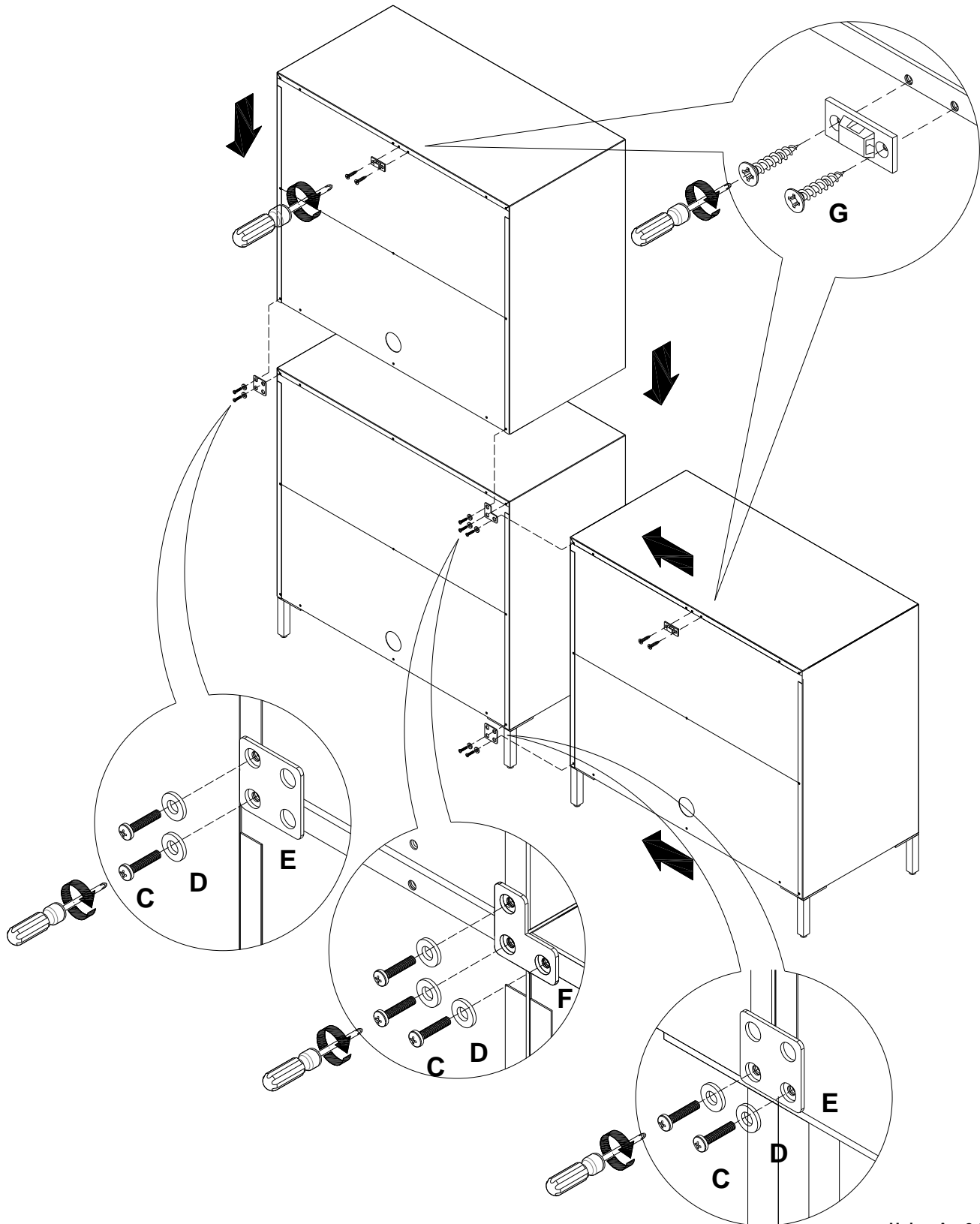

5 Note : Always put the one drawer on the bottom, do not recommend to put the one drawer to the top of the case.

Remarque : Toujours placer le tiroir unique au bas, il n'est pas recommandé de le placer en haut du cadre

Nota: Siempre colocar el cajón en la parte inferior. No es recomendable colocar el cajón en la parte superior

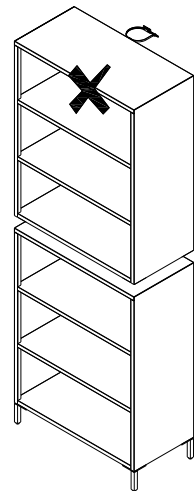
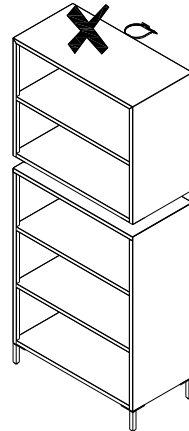
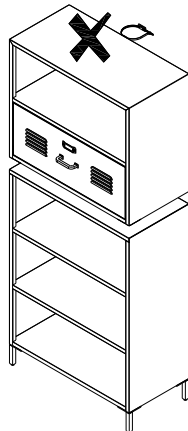
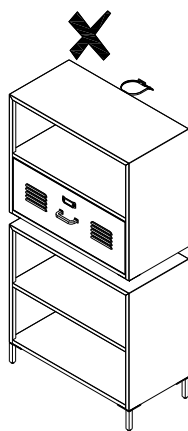
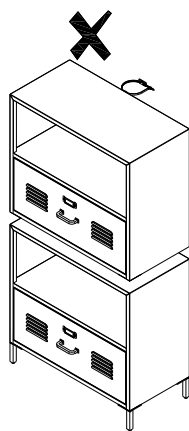
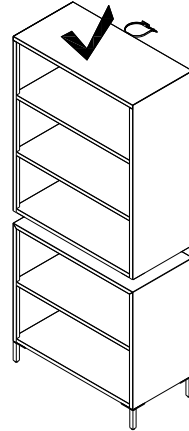
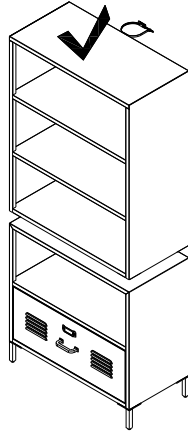
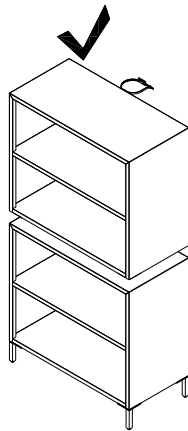
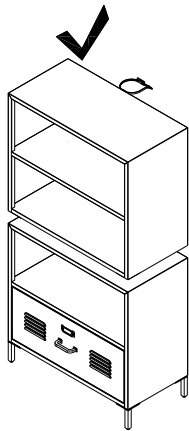

6 Configuration Locker Wall System (Sold separately) Configuration du système mural de casier (vendu séparément) Configuración del sistema de armario para pared (se vende por separado)

Note : Always put the one drawer on the bottom, do not recommend to put the one drawer to the top of the case.

Remarque : Toujours placer le tiroir unique au bas, il n'est pas recommandé de le placer en haut du cadre

Nota: Siempre colocar el cajón en la parte inferior. No es recomendable colocar el cajón en la parte superior de la caja.

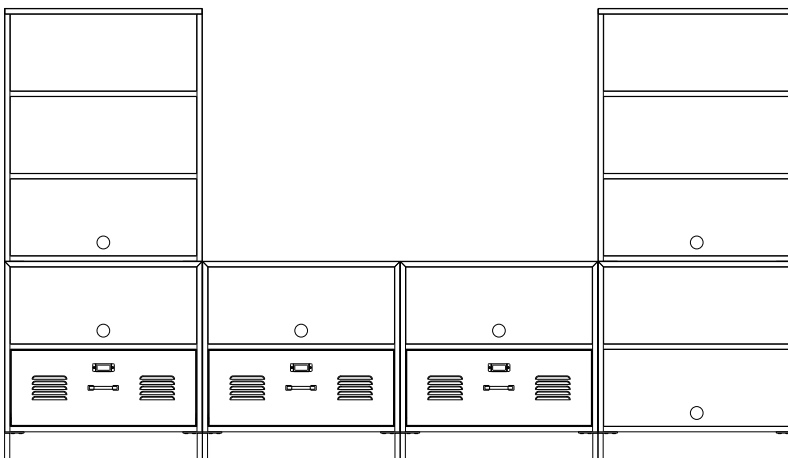
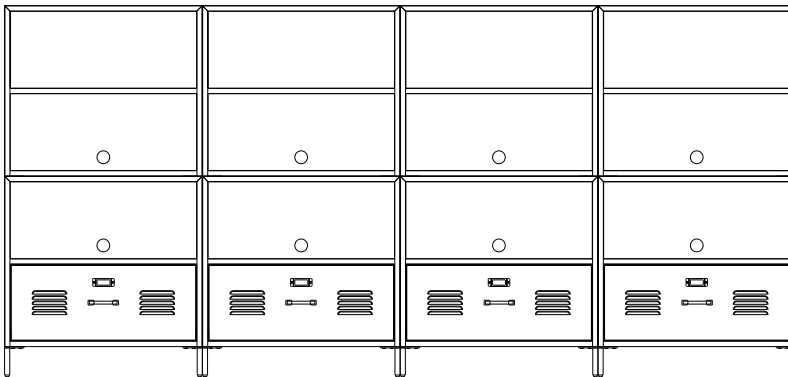
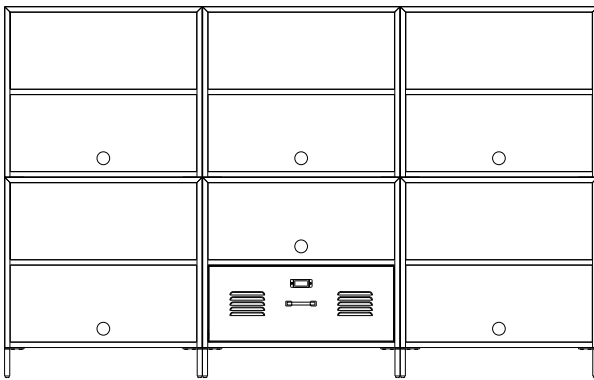

7

