



# Tune-in bed (Queen)

**Pre-Assembly:**

- Please read all instructions before beginning assembly.
- Save all packing materials until assembly is complete to avoid accidentally discarding smaller parts or hardware.

**Parts Included:**

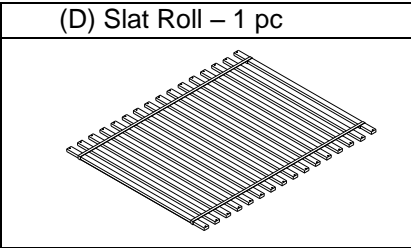
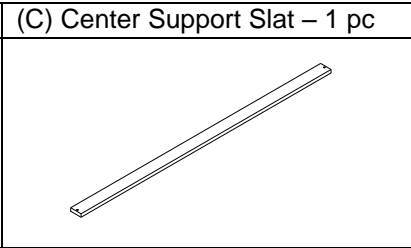
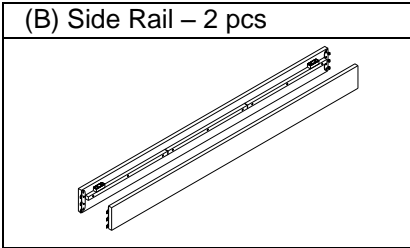
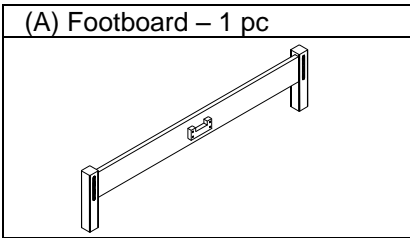

**Hardware Enclosed:**

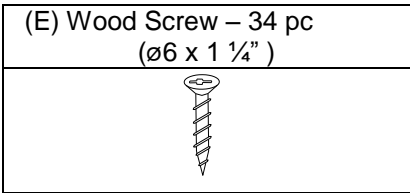

**Tools Required:**  
Phillips head screwdriver (not included)

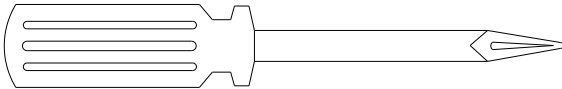

## Assembly Instructions:

1. Attach each side rail (B) to the Footboard (A) and Headboard Only by inserting the teeth into grooves. Press down to secure. Fig. 1
2. Place the center support slat onto the wood block on the Headboard Only and footboard (A). Secure with two wood screws (E). Fig. 2
3. Roll out slats (D) onto side rails (B), positioning the two end slats at the ends of the side rails. Using a Phillips head screwdriver to fasten two end of each slat to side rails with wood screws (E). Fig. 3

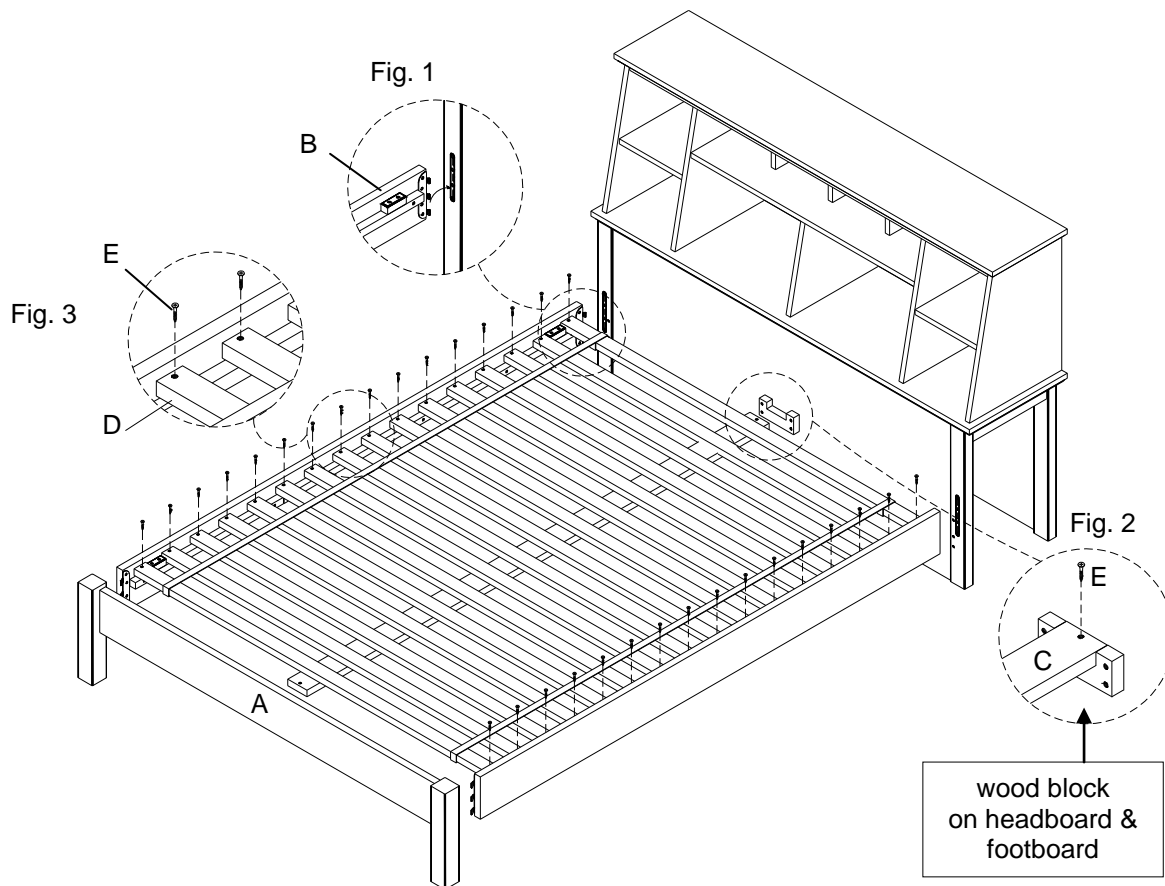

Assembly is completed.

## Care Instructions:

- Dust often with a soft, dry cloth.
- To clean, slightly moisten cloth with water (a damp cloth will hold dust and prevent scratching; dry thoroughly).