

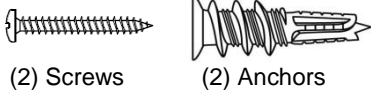

Antiqued Paneled Mirror: Diamond

Mounting Instruction

HARDWARE INCLUDED:



(2) Screws

(2) Anchors

Note: The provided mounting hardware is meant for drywall and stud construction only. For other wall types, please consult your local hardware store for assistance in selecting the appropriate hardware.

TOOLS NEEDED (not included):

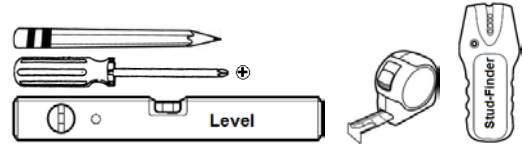

Hanging Orientation Options:

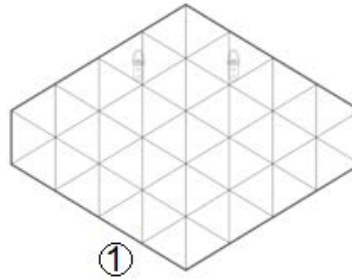

①

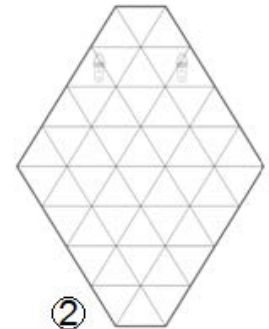

②

Mounting Instructions:

1 Measure the exact distance between the center of D-rings.

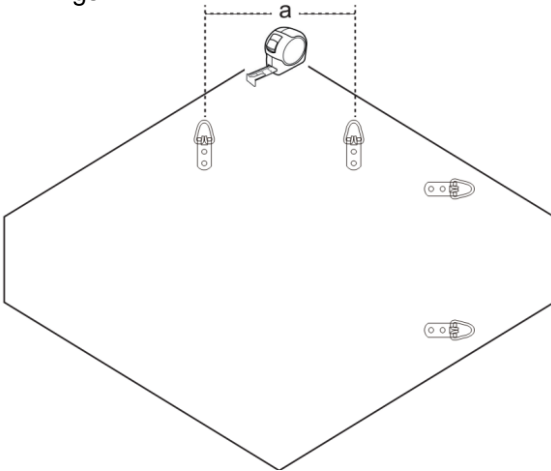

2 With the back of the item facing away from the wall, hold it against the wall at a desired mounting location. Mark two reference points (A, B) on the wall as shown.

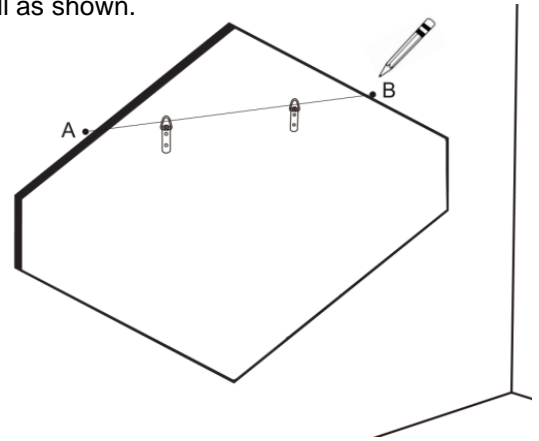

3 Connect the two points (A, B) with a light pencil line. Use a level to ensure that the line is level.

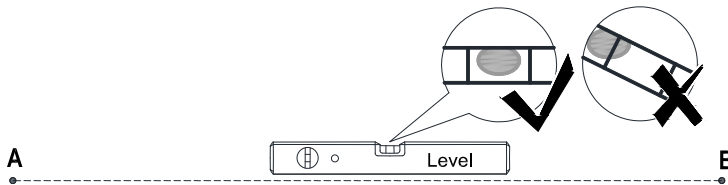

4 Make two insertion marks (C, D) centered along the line using the measurement "a".

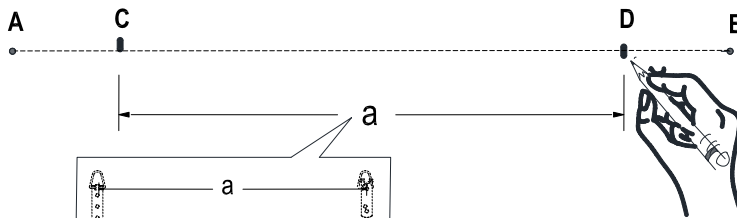

- 5** Use a stud-finder to determine if there is a wall stud located at either insertion mark. Install the proper hardware, as shown below. Note that the head of each screw resides about 3/8" from the wall.



For stud mounting:

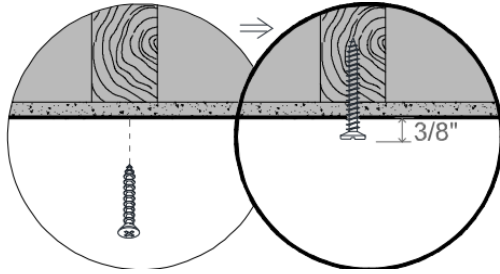

For non-stud mounting:

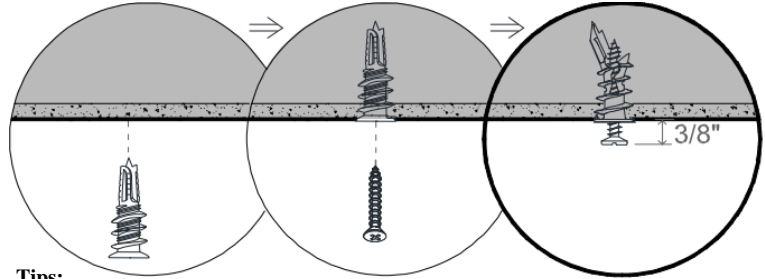

Tips:
The anchor is self-drillable.
No pilot hole required.

- 6** Hang the item to the wall so that the D-rings engage the screw heads.

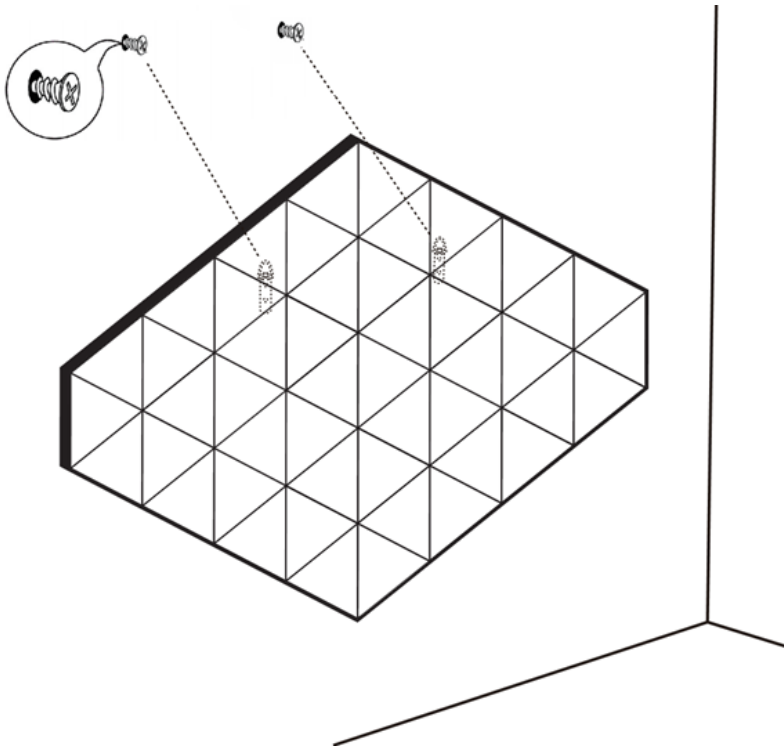

Care Instructions:

- To clear: Wipe with a soft, dry or slightly damp cloth.
- Do not use abrasive or strong chemical household cleaners.

Thank you for your purchase.
Stores | Catalog | www.pbteen.com