

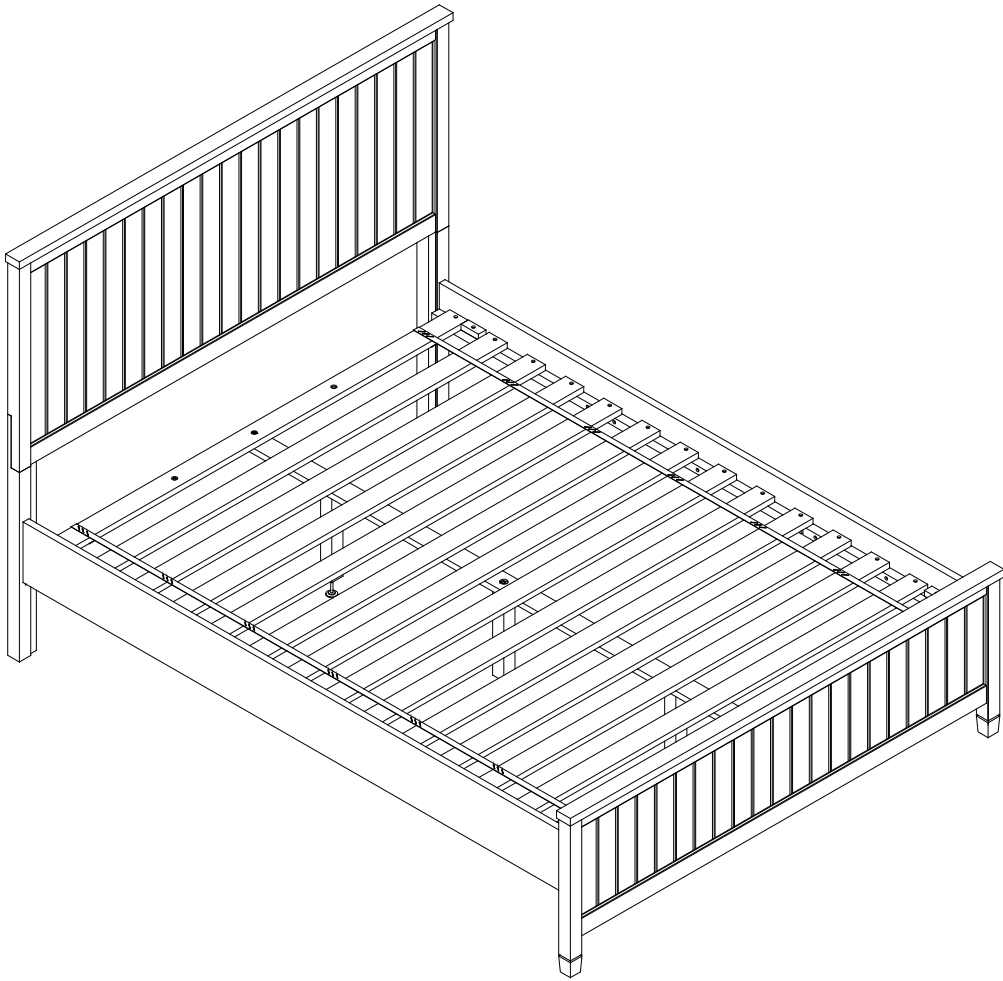

BEADBOARD BASIC BED
QUEEN
ASSEMBLY INSTRUCTIONS







Important Safety Instructions:

- Please read all instructions carefully before assembling this bed.
- For your safety, assembly by two or more adults is strongly recommended.
- Keep these instructions for future use.
- Use only vendor-supplied hardware to assemble this item. Using unauthorized hardware could jeopardize the structural integrity of the item.

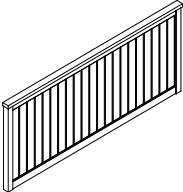
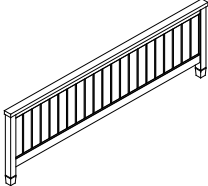

Pre-assembly:

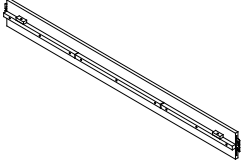
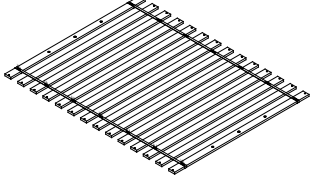
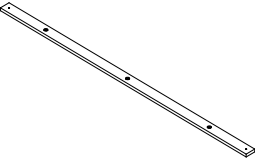
- Remove all parts and hardware from the box. Place them on a carpeted or scratch-free work surface, as this will avoid damaging parts during assembly. The shipping box provides an ideal work surface.
- To avoid accidentally discarding small parts or hardware, do not dispose of any packaging or contents of the shipping carton until assembly is complete.
- Use the parts and hardware lists below to identify, and separate each of the pieces included.
- The illustrations provided allow for easier assembly when used in conjunction with the assembly instructions.
- The use of power tools to aid in assembly is not recommended. Power tools can damage the hardware and split the wood.

Parts Included:

 <p>(A) Headboard – 1x</p>	 <p>(B) Footboard – 1x</p>	 <p>(C) Left Headboard Leg – 1x</p>
 <p>(D) Right Headboard Leg – 1x</p>	 <p>(E) Side Rail – 2x</p>	 <p>(F) Slat Roll – 1x</p>
 <p>(G) Support Rail – 1x</p>	 <p>(H) Support Leg – 3x</p>	

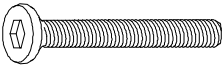
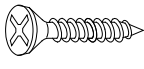
Hardware Included:



 <p>(I) Allen Key – 1x</p>	 <p>(J) Bolt 5/16"x 35mm – 6x</p>	 <p>(K) Wood Screw 4x30mm – 28x</p>
 <p>(L) Spring Washer 5/16" – 6x</p>	 <p>(M) Flat Washer 5/16" – 6x</p>	

Tools Required:

Philips Head Screw Driver  (not included)

Assembly Instruction Steps:

1. Attach the Left and Right Headboard Legs (C&D) to the posts of Headboard (A), as seen in the illustration below.
2. Secure with 4 sets of Bolt (J), Spring Washer (L), and Flat Washer (M) through the pre-drilled holes found on the Left and Right Headboard Legs (C&D) and into the pre-fixed mounting plates of the Headboard (A) posts.
3. Tighten with Allen Key (I).

J		4x
L		4x
M		4x

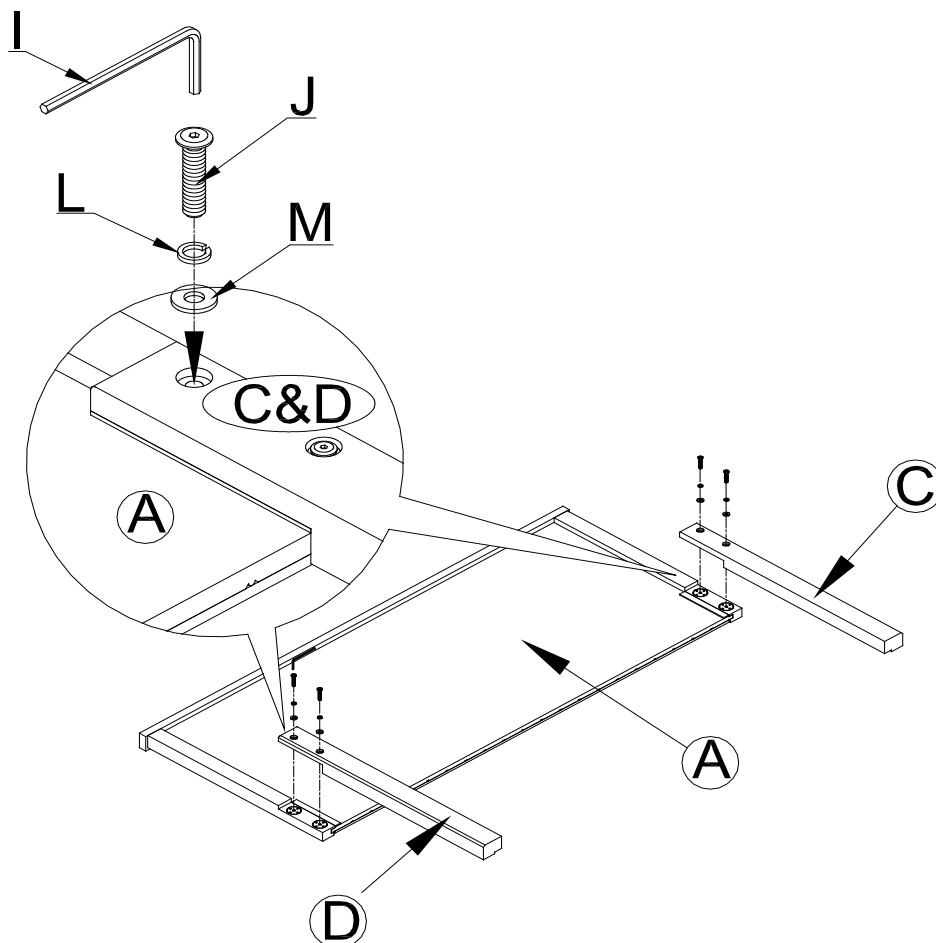

4. Determine the desired location of bed and then hold the assembled Headboard (A) in a vertical position-tilted slightly forward.
5. Attach each Side Rail (E) to Left & Right Headboard Legs (C&D) by inserting the hook (pre-attached at the ends of the Side Rail) into the corresponding slots of the Left & Right Headboard Legs (C&D).
6. Push down firmly on the top of the Side Rails (E) until they sit themselves over the pins inside leg slots, as shown in the illustration below. Be sure the small ledge on each Side Rail (E) is facing inward.

There are two levels for the Side Rails (E). If you plan to use a trundle, please use the higher setting.

7. Repeat with steps #5 and #6 to assemble the Footboard (B), as seen in the illustration below.

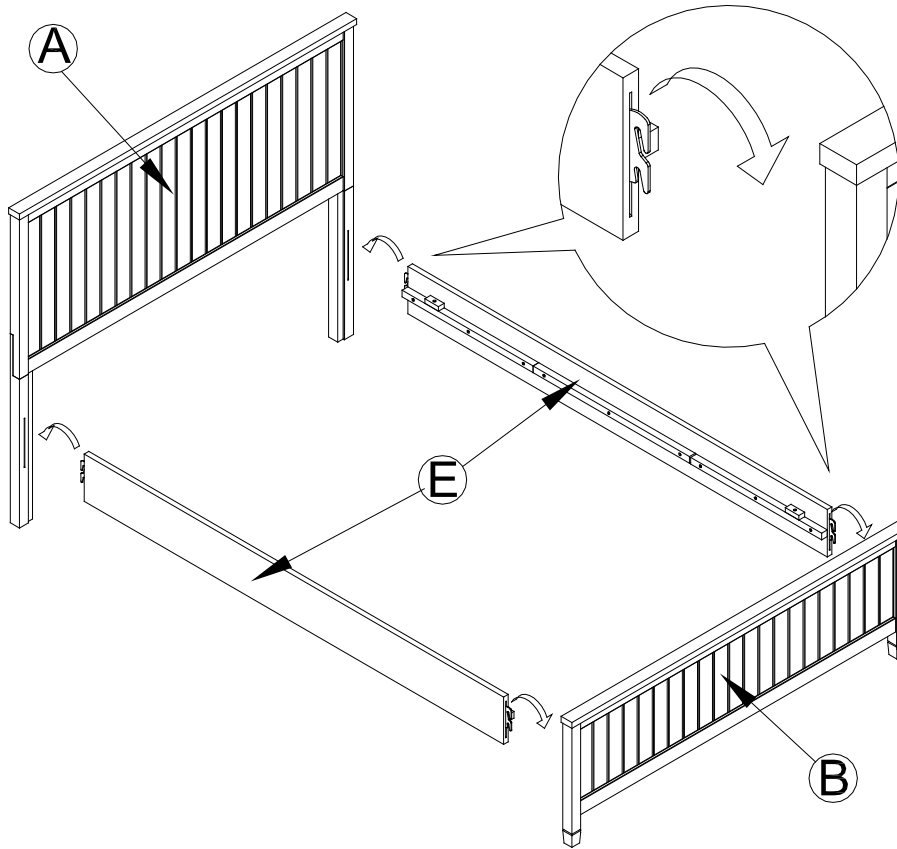

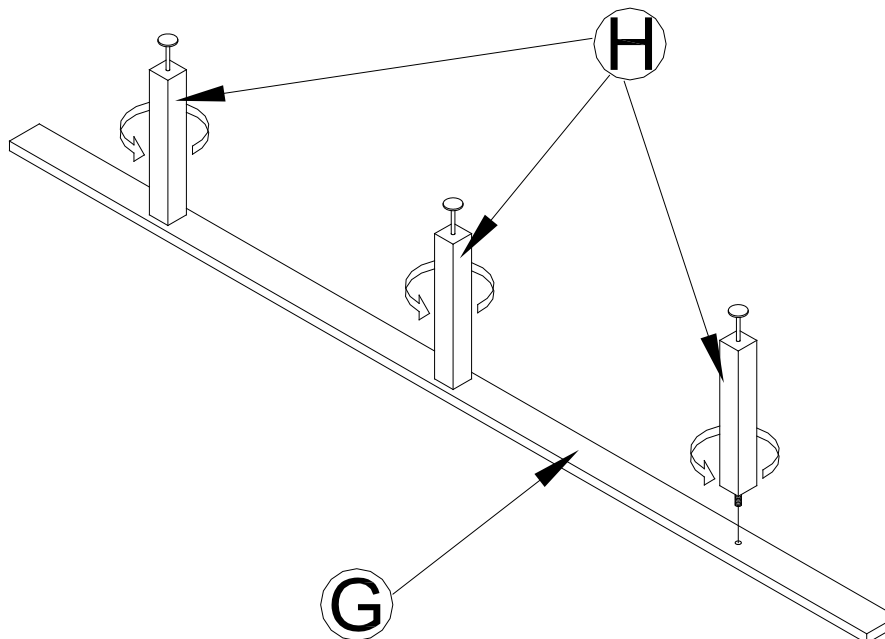

8. Thread the 3 Support Legs (H) into the pre-fixed insert nuts of the Support Rail (G), as seen in the illustration below.



9. Attach the assembled Support Rail (G) and Support Leg (H) to the Slats Roll (F).

10. Connect the 1st slat to one end of the Support Rail (G) by inserting Bolt (J), Spring Washer (L), and Flat Washer (M) through the pre-drilled holes of the 1st slat and into the pre-fixed insert nuts of Support Rail (G), as seen in the illustration below.

11. Tighten with Allen Key (I).
12. Repeat steps # 9 and #10 at the other end of Support Rail (G).
13. **NOTE:** Three positions for Support Rail (G) are provided. The center position is used without a trundle. If using a trundle, please assemble Support Rail (G) to the pre-drilled holes on the opposite side of the bed where you desire the trundle to be used. This provides enough room for trundle not to hit the Support Legs (H).

J		2x
L		2x
M		2x

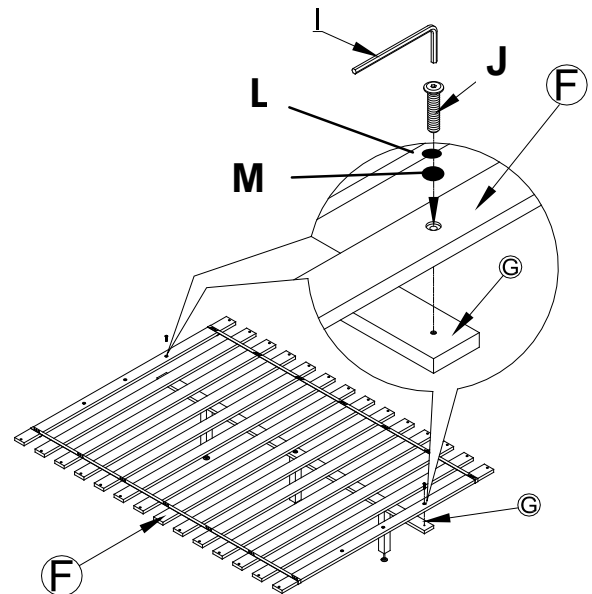
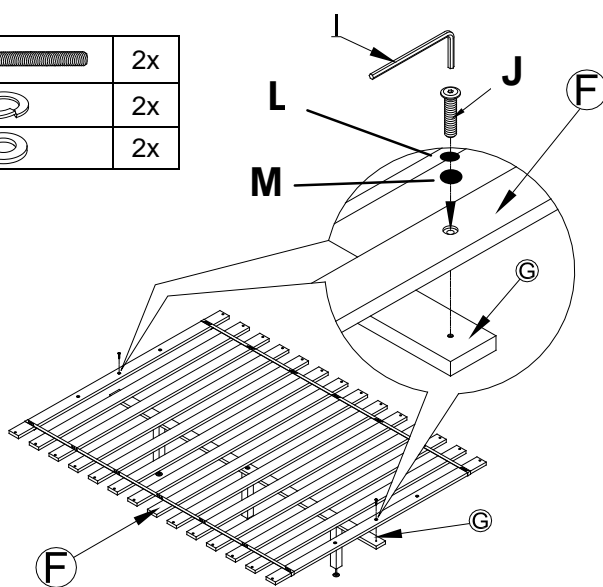

14. Lay Slat Roll (F) with the assembled Support Rail (G) and Support Leg (H) in the bed.
15. Insert 28 Wood Screws (K) to secure the slats.
16. Tighten with a Phillips Head Screwdriver (not provided).
17. When needed, adjust the levelers located under the Support Legs (H) to keep the whole bed level.

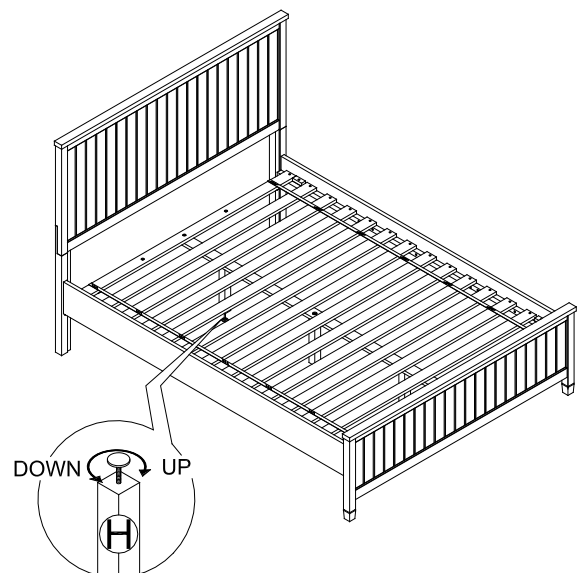
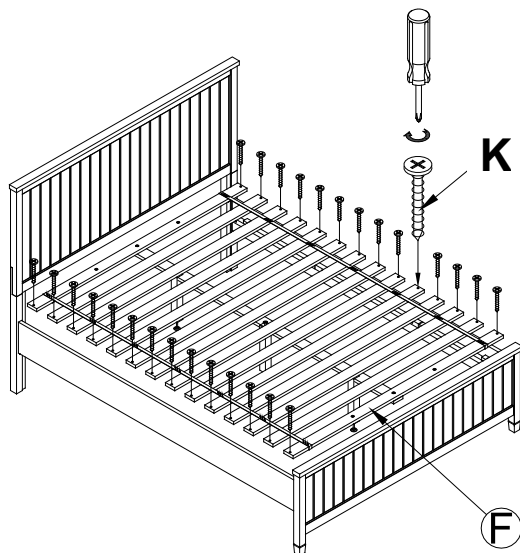

K		28x
---	---	-----

Care Instructions:

- Dust often using a clean, soft, dry, and lint-free cloth.
- Blot spills immediately and wipe with a clean, damp cloth.
- We do not recommend the use of chemical cleansers, abrasives, or furniture polish on our lacquered finish.
- Hardware may loosen over time. Periodically check to make sure all connections are tight. Re-tighten if necessary.